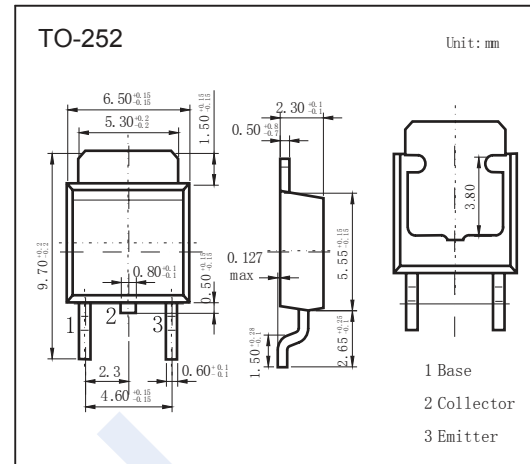

PNP Transistors

2SB1275

■ Features

- High voltage : $V_{CE0} = -160V$
- Suitable for Middle Power Driver
- Complementary to 2SD1918

■ Absolute Maximum Ratings $T_a = 25^\circ C$

Parameter	Symbol	Rating	Unit	
Collector - Base Voltage	V_{CBO}	-160	V	
Collector - Emitter Voltage	V_{CEO}	-160		
Emitter - Base Voltage	V_{EBO}	-5		
Collector Current - Continuous	I_C	-1.5	A	
Collector Current - Pulse	I_{CP}	-3		
Collector Power Dissipation	P_C	$T_c = 25^\circ C$	10	W
		$T_a = 25^\circ C$	1	
Junction Temperature	T_J	150	$^\circ C$	
Storage Temperature range	T_{stg}	-55 to 150		

■ Electrical Characteristics $T_a = 25^\circ C$

Parameter	Symbol	Test Conditions	Min	Typ	Max	Unit
Collector- base breakdown voltage	V_{CBO}	$I_C = -100 \mu A, I_E = 0$	-160			V
Collector- emitter breakdown voltage	V_{CEO}	$I_C = -1 mA, R_{BE} = \infty$	-160			
Emitter - base breakdown voltage	V_{EBO}	$I_E = -100 \mu A, I_C = 0$	-5			
Collector-base cut-off current	I_{CBO}	$V_{CB} = -120V, I_E = 0$			-1	μA
Emitter cut-off current	I_{EBO}	$V_{EB} = -4V, I_C = 0$			-1	
Collector-emitter saturation voltage	$V_{CE(sat)}$	$I_C = -1 A, I_B = -100 mA$			-2	V
Base - emitter saturation voltage	$V_{BE(sat)}$	$I_C = -1 A, I_B = -100 mA$			-1.2	
DC current gain	h_{FE}	$V_{CE} = -5V, I_C = -100 mA$	82		180	
Collector output capacitance	C_{ob}	$V_{CB} = -10V, I_E = 0, f = 1MHz$		30		μF
Transition frequency	f_T	$V_{CE} = -5V, I_E = 100 mA, f = 30MHz$		50		MHz

■ Classification of h_{FE}

Type	2SB1275-P
Range	82-180

PNP Transistors

2SB1275

■ Typical Characteristics

Fig.1 Ground Emitter Propagation Characteristics

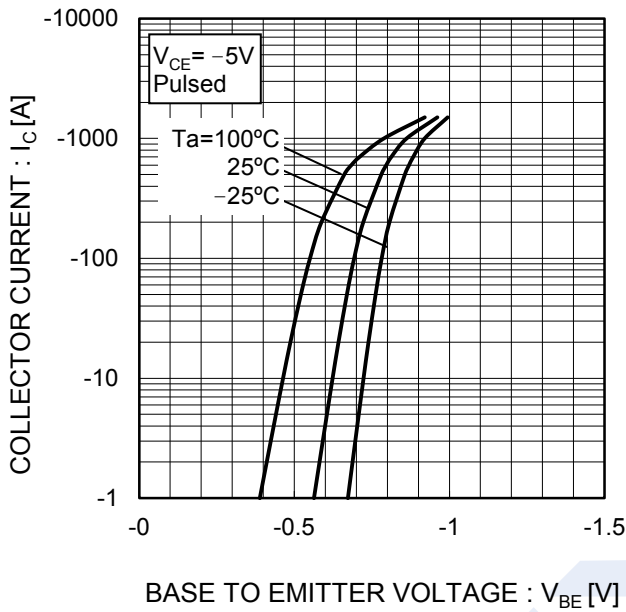

Fig.2 Typical Output Characteristics

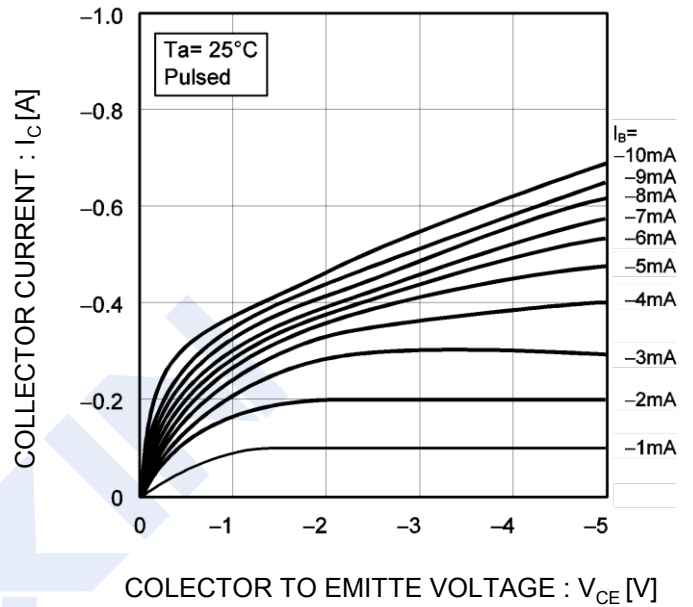

Fig.3 DC Current Gain vs. Collector Current(I)

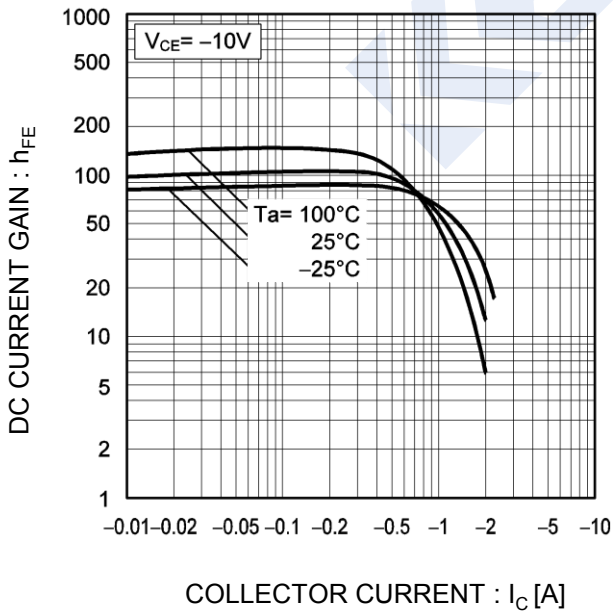
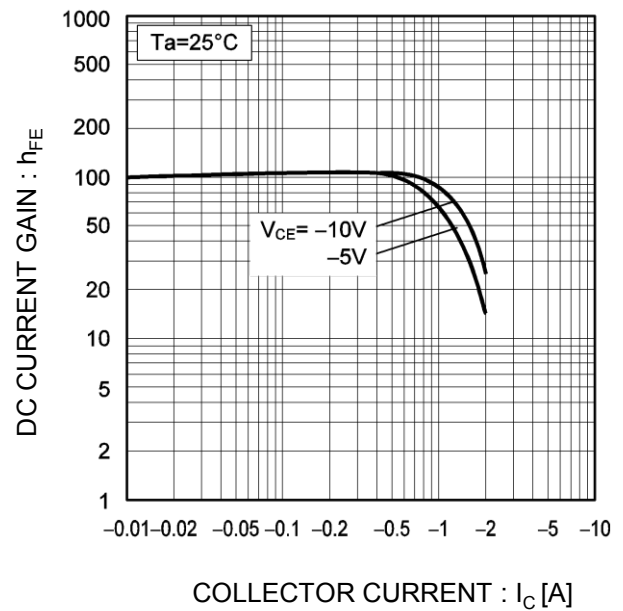

Fig.4 DC current gain vs. output current (II)



PNP Transistors

2SB1275

■ Typical Characteristics

Fig.5 Collector-Emitter Saturation Voltage vs. Collector Current (I)

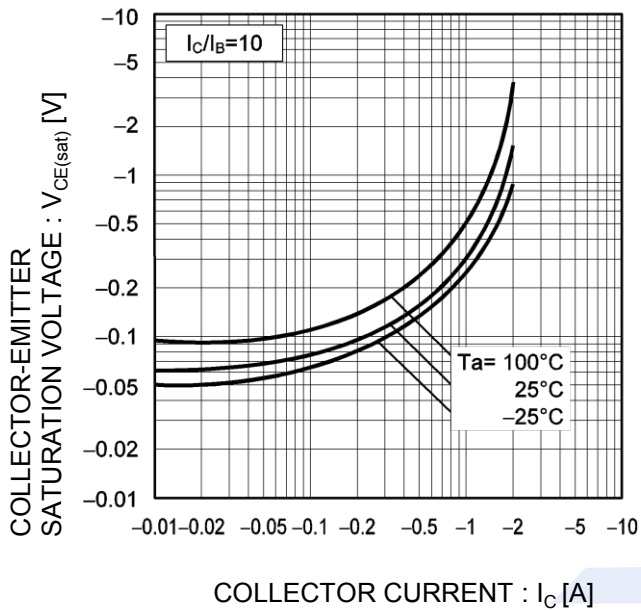

Fig.6 Collector-Emitter Saturation Voltage vs. Collector Current (II)

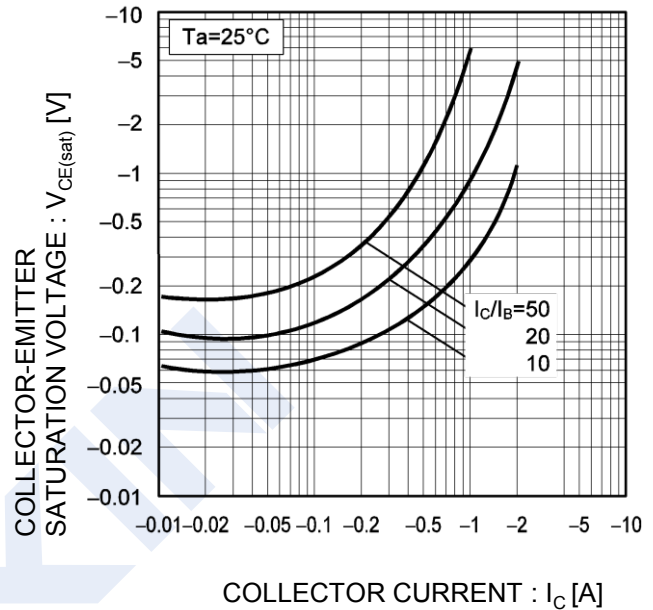

Fig.7 Base-Emitter Saturation Voltage vs. Collector Current

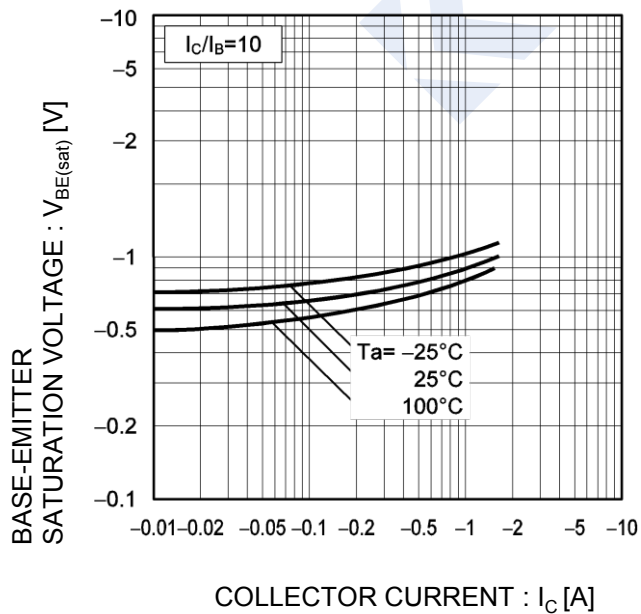
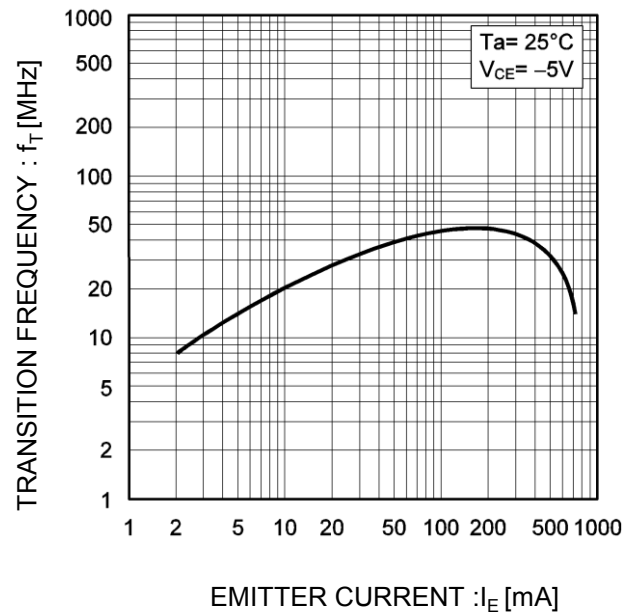

Fig.8 Gain Bandwidth Product vs. Emitter Current



PNP Transistors

2SB1275

■ Typical Characteristics

Fig.9 Collector output capacitance vs. Collector-Base Voltage

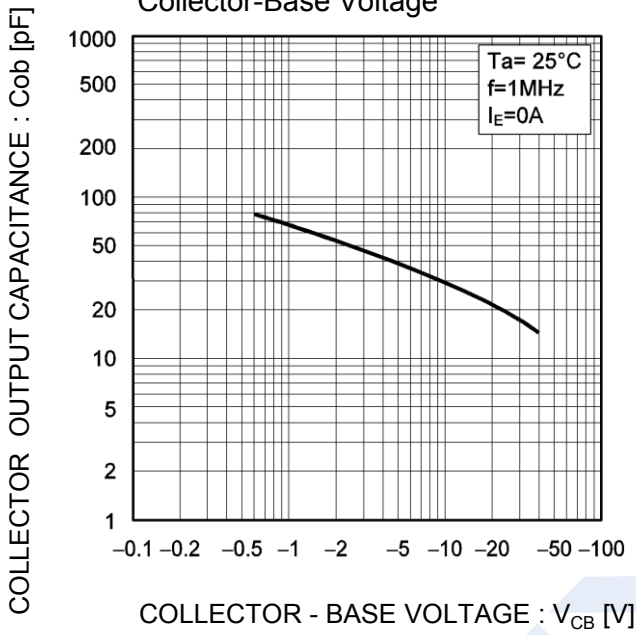

Fig.10 Safe Operating Area

