

N-Channel MOSFET

2SK3305-ZJ

■ Features

- $V_{DS} = 500V$
- $I_D = 5A$ ($V_{GS} = 10V$)
- $R_{DS(ON)} < 1.5\Omega$ ($V_{GS} = 10V$)
- Gate voltage rating: $\pm 30V$
- Avalanche capability ratings

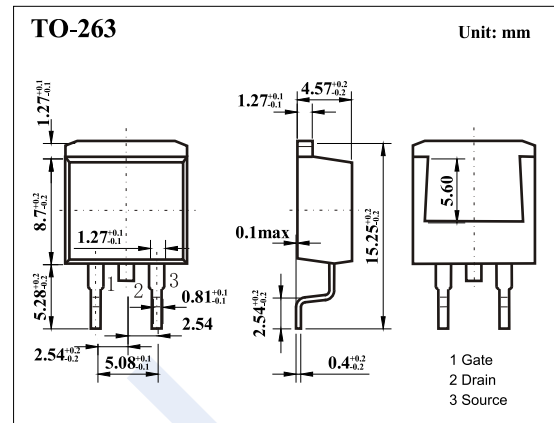
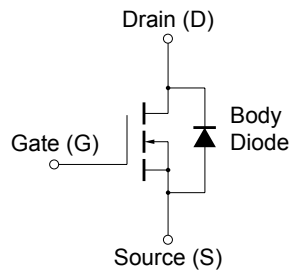

■ Absolute Maximum Ratings $T_a = 25^\circ C$

Parameter	Symbol	Rating	Unit	
Drain-Source Voltage	V_{DS}	500	V	
Gate-Source Voltage	V_{GS}	± 30		
Continuous Drain Current	I_D	5	A	
Pulsed Drain Current (Note.1)	I_{DM}	20		
Single Avalanche Current (Note.2)	I_{AS}	5		
Power Dissipation	P_D	$T_c = 25^\circ C$	75	W
		$T_a = 25^\circ C$	1.5	
Single Avalanche Energy (Note.2)	E_{AS}	125	mJ	
Junction Temperature	T_J	150	$^\circ C$	
Storage Temperature Range	T_{stg}	-55 to 150		

Note.1: $PW \leq 10 \mu s$, Duty Cycle $\leq 1\%$

Note.2: Starting $T_J = 25^\circ C$, $V_{DD} = 150V$, $R_G = 25\Omega$, $V_{GS} = 20V \rightarrow 0V$

N-Channel MOSFET

2SK3305-ZJ

■ Electrical Characteristics Ta = 25°C

Parameter	Symbol	Test Conditions	Min	Typ	Max	Unit
Drain-Source Breakdown Voltage	V _{DSS}	I _D =250 μA, V _{GS} =0V	500			V
Zero Gate Voltage Drain Current	I _{DSS}	V _{DS} =500V, V _{GS} =0V			100	μA
Gate-Body Leakage Current	I _{GSS}	V _{DS} =0V, V _{GS} =±30V			±100	nA
Gate to Source Cut-off Voltage	V _{GS(off)}	V _{DS} =10V, I _D =1mA	2.5		3.5	V
Static Drain-Source On-Resistance	R _{DS(on)}	V _{GS} =10V, I _D =2.5A			1.5	Ω
Forward Transconductance	g _{Fs}	V _{DS} =10V, I _D =2.5A	1	3		S
Input Capacitance	C _{iss}	V _{GS} =0V, V _{DS} =10V, f=1MHz		700		pF
Output Capacitance	C _{oss}			115		
Reverse Transfer Capacitance	C _{rss}			6		
Total Gate Charge	Q _g	V _{GS} =10V, V _{DS} =400V, I _D =5A		13		nC
Gate Source Charge	Q _{gs}			4		
Gate Drain Charge	Q _{gd}			4.5		
Turn-On DelayTime	t _{d(on)}	V _{DD} = 150 V, I _D = 2.5 A, V _{GS(on)} = 10 V, R _G = 10 Ω, R _L = 60 Ω		16		ns
Turn-On Rise Time	t _r			3		
Turn-Off DelayTime	t _{d(off)}			33		
Turn-Off Fall Time	t _f			5.5		
Body Diode Reverse Recovery Time	t _{rr}	I _F = 5A, V _{GS} =0, di/dt= 50A/μs		600		μs
Body Diode Reverse Recovery Charge	Q _{rr}			3.3		
Diode Forward Voltage	V _{SD}	I _F =5A, V _{GS} =0V		0.9		V

■ Typical Characteristics

Figure1. DERATING FACTOR OF FORWARD BIAS SAFE OPERATING AREA

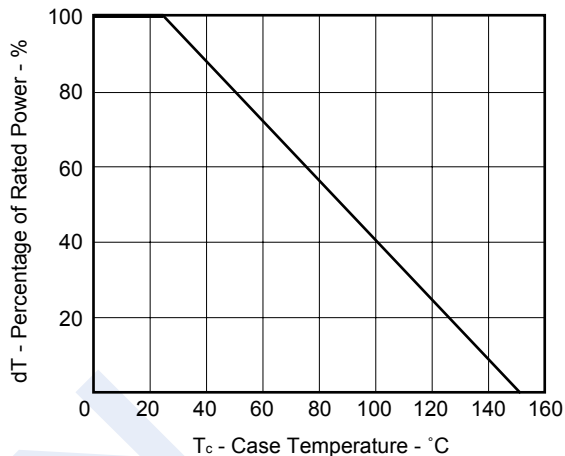
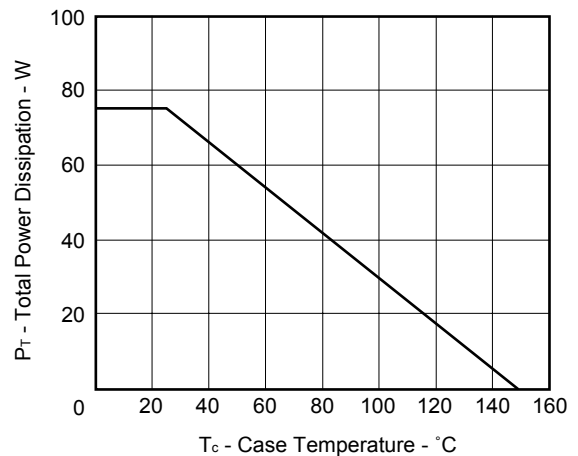

Figure2. TOTAL POWER DISSIPATION vs. CASE TEMPERATURE



N-Channel MOSFET 2SK3305-ZJ

■ Typical Characteristics

Figure3. FORWARD BIAS SAFE OPERATING AREA

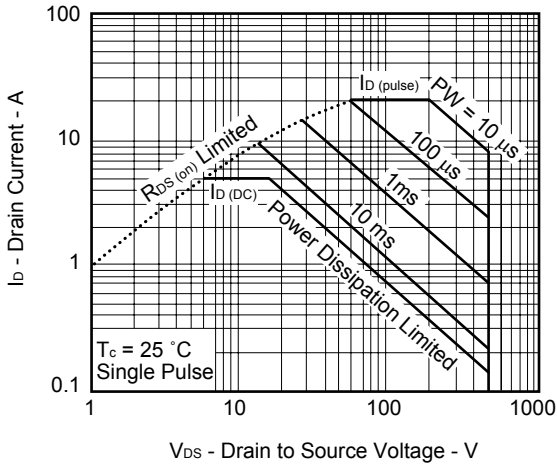

Figure4. DRAIN CURRENT vs. DRAIN TO SOURCE VOLTAGE

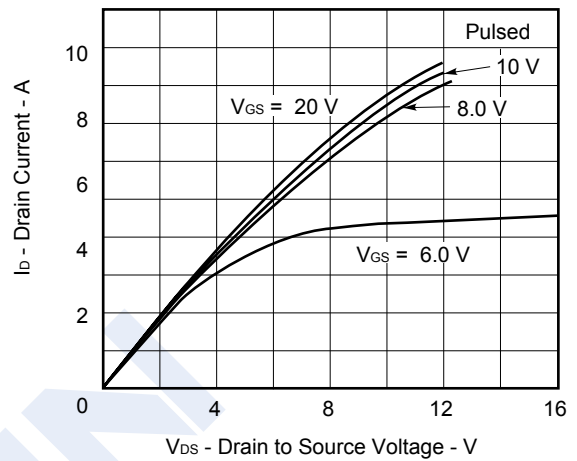

Figure5. DRAIN CURRENT vs. GATE TO SOURCE VOLTAGE

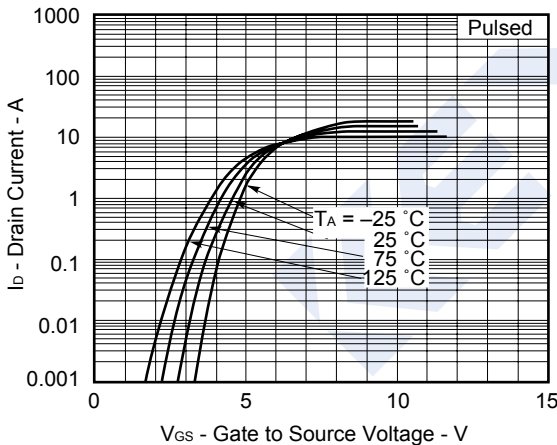
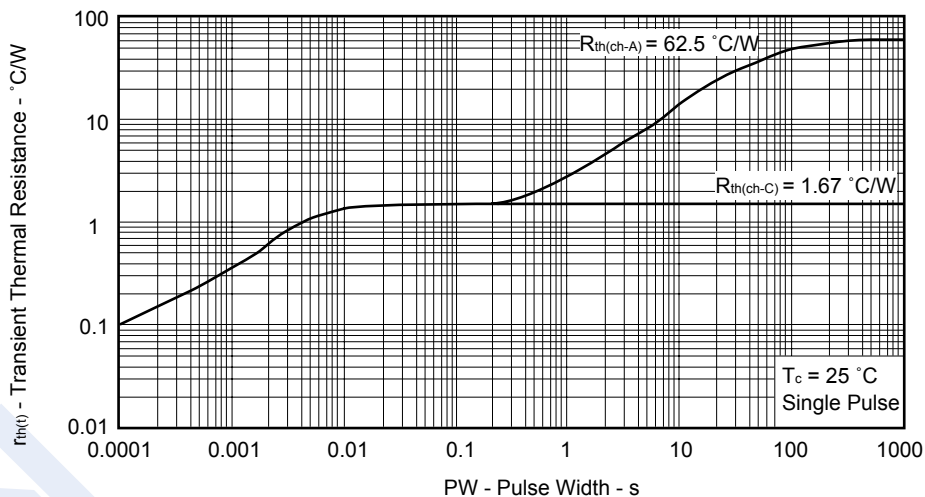

Figure6. TRANSIENT THERMAL RESISTANCE vs. PULSE WIDTH



N-Channel MOSFET 2SK3305-ZJ

Typical Characteristics

Figure7. FORWARD TRANSFER ADMITTANCE vs. DRAIN CURRENT

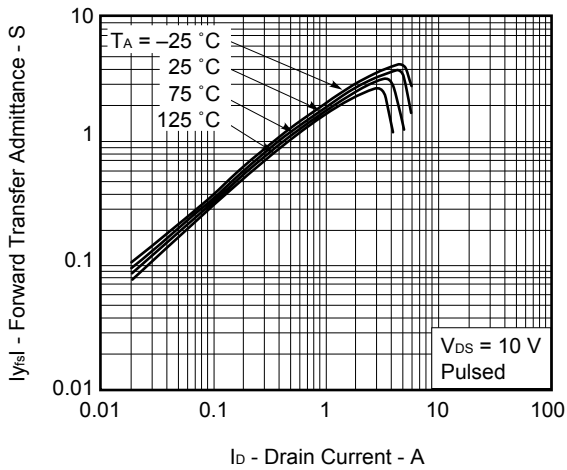

Figure8. DRAIN TO SOURCE ON-STATE RESISTANCE vs. GATE TO SOURCE VOLTAGE

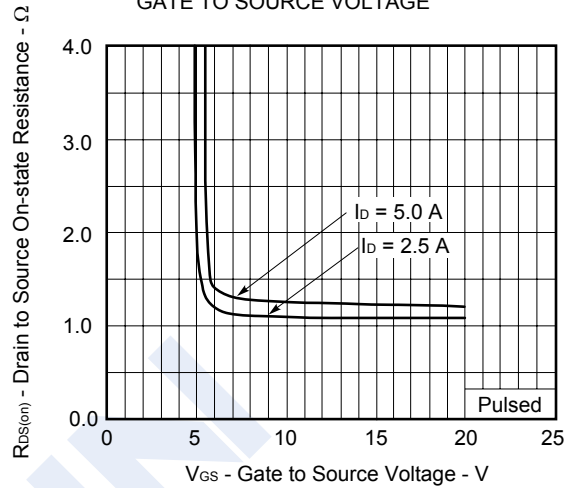

Figure9. DRAIN TO SOURCE ON-STATE RESISTANCE vs. DRAIN CURRENT

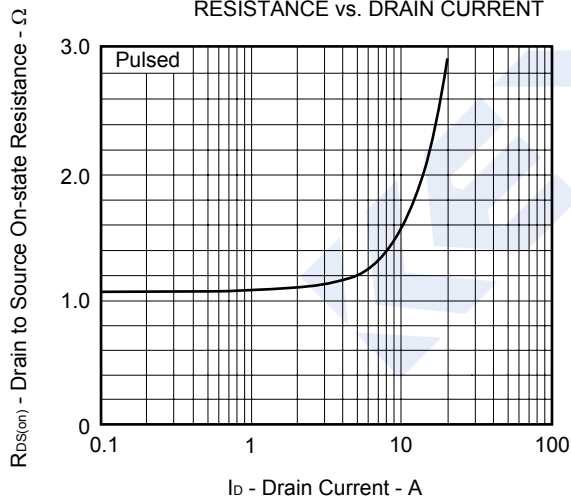

Figure10. GATE TO SOURCE CUT-OFF VOLTAGE vs. CHANNEL TEMPERATURE

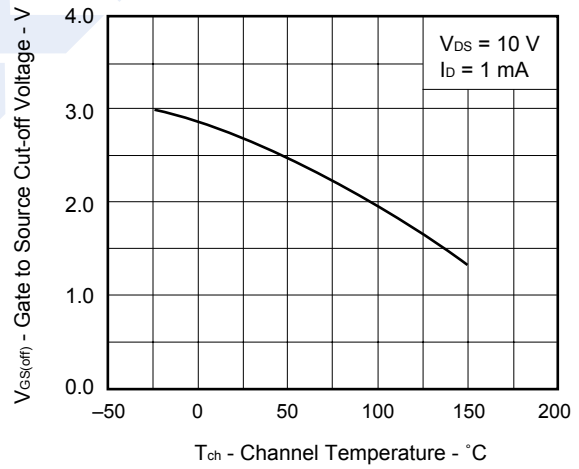

Figure11. DRAIN TO SOURCE ON-STATE RESISTANCE vs. CHANNEL TEMPERATURE

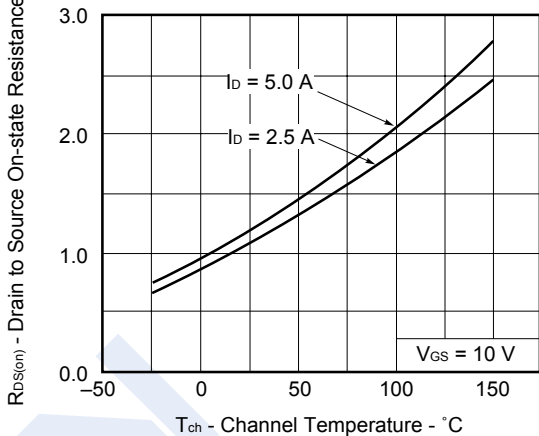
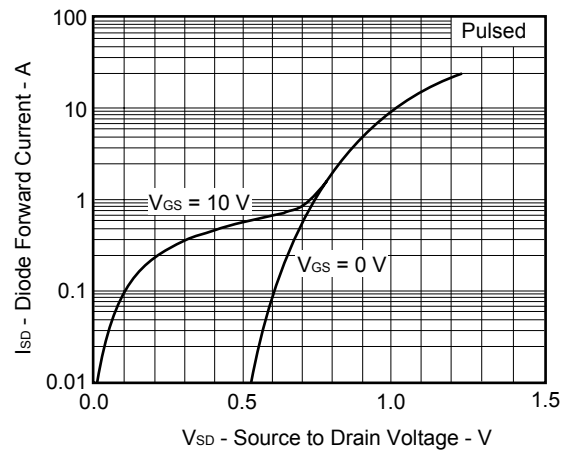

Figure12. SOURCE TO DRAIN DIODE FORWARD VOLTAGE



N-Channel MOSFET 2SK3305-ZJ

■ Typical Characteristics

Figure13. CAPACITANCE vs. DRAIN TO SOURCE VOLTAGE

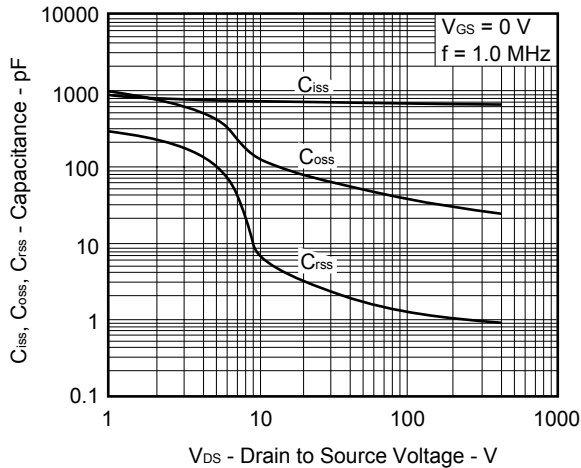

Figure15. REVERSE RECOVERY TIME vs. DRAIN CURRENT

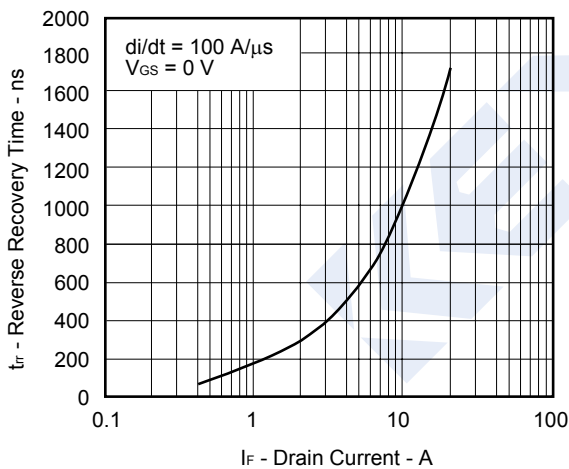

Figure17. SINGLE AVALANCHE ENERGY vs. STARTING CHANNEL TEMPERATURE

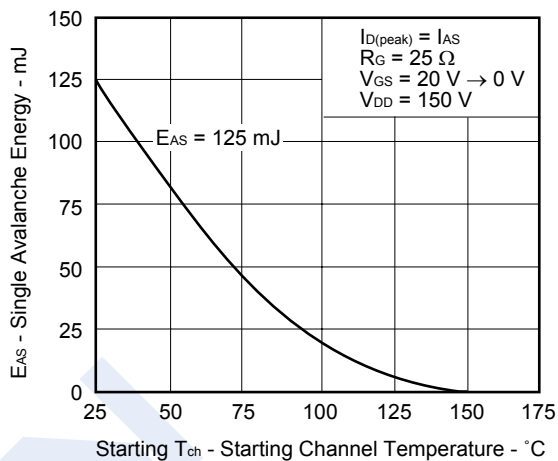

Figure14. SWITCHING CHARACTERISTICS

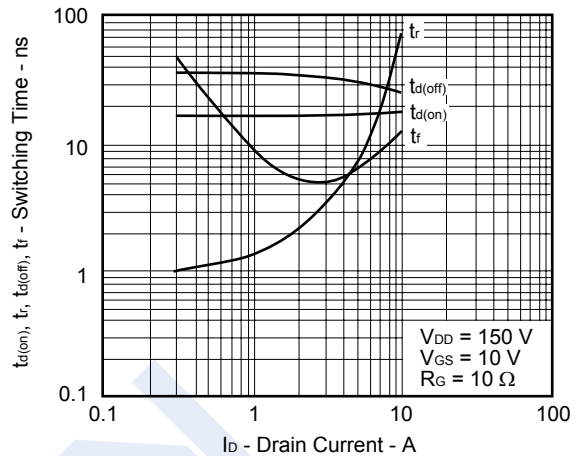

Figure16. DYNAMIC INPUT/OUTPUT CHARACTERISTICS

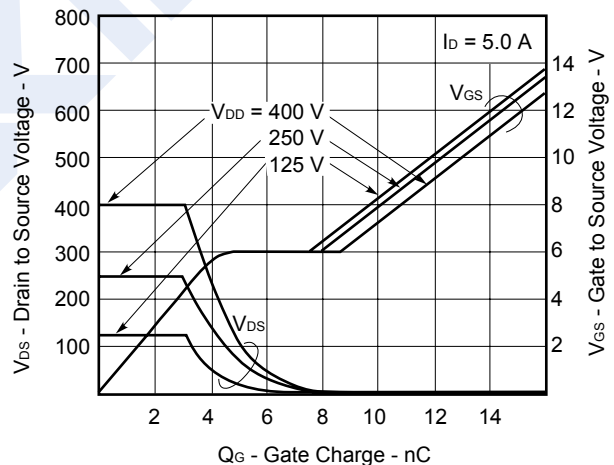

Figure18. SINGLE AVALANCHE CURRENT vs. INDUCTIVE LOAD

