

NPN Medium Power Transistor

BCP56-16

■ Features

- For AF driver and output stages
- High collector current
- Low collector-emitter saturation voltage

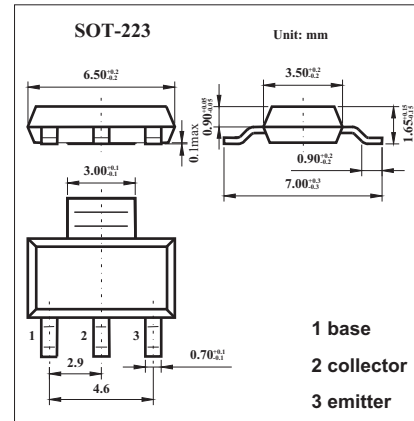

■ Absolute Maximum Ratings $T_a = 25^\circ\text{C}$

Parameter	Symbol	Rating	Unit
collector-base voltage	V_{CB0}	100	V
collector-emitter voltage	V_{CE0}	80	V
emitter-base voltage	V_{EB0}	5	V
collector current (DC)	I_C	1	A
peak collector current ($t_P < 5\text{ms}$)	I_{CM}	1.5	A
power dissipation	P_D	1.5	W
thermal resistance from junction to ambient	$R_{\theta JA}$	94	$^\circ\text{C}/\text{W}$
junction temperature	T_j	150	$^\circ\text{C}$
storage temperature	T_{stg}	-65 to +150	$^\circ\text{C}$

■ Electrical Characteristics $T_a = 25^\circ\text{C}$

Parameter	Symbol	Testconditions	Min	Typ	Max	Unit
Collector-base breakdown voltage	$V_{(BR)CBO}$	$I_C = 0.1\text{mA}, I_E = 0$	100			
Collector-emitter breakdown voltage	$V_{(BR)CEO}$	$I_C = 10\text{mA}, I_B = 0$	80			
Base-emitter breakdown voltage	$V_{(BR)EBO}$	$I_C = 10\mu\text{A}, I_E = 0$	5			
Collector cut-off current	I_{CBO}	$I_E = 0\text{A}; V_{CB} = 30\text{V}$			100	nA
Emitter cut-off current	I_{EBO}	$I_C = 0\text{A}; V_{EB} = 5\text{V}$			100	nA
DC current gain	h_{FE}	$I_C = 5\text{mA}; V_{CE} = 2\text{V}$	25			
		$I_C = 150\text{mA}; V_{CE} = 2\text{V}$	100		250	
		$I_C = 500\text{mA}; V_{CE} = 2\text{V}$	25			
Collector-emitter saturation voltage	$V_{CE(sat)}$	$I_C = 500\text{mA}; I_B = 50\text{mA}$			0.5	V
Transition frequency	f_T	$I_C = 10\text{mA}; V_{CE} = 5\text{V}; f = 100\text{MHz}$		130		MHz

■ Marking

Marking	BCP 56
---------	--------

BCP56-16

■ Typical Characteristics

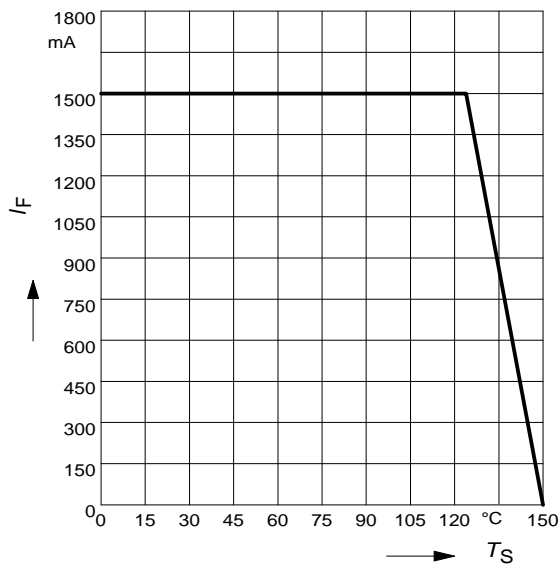

Total power dissipation $P_{tot} = f(T_S)$

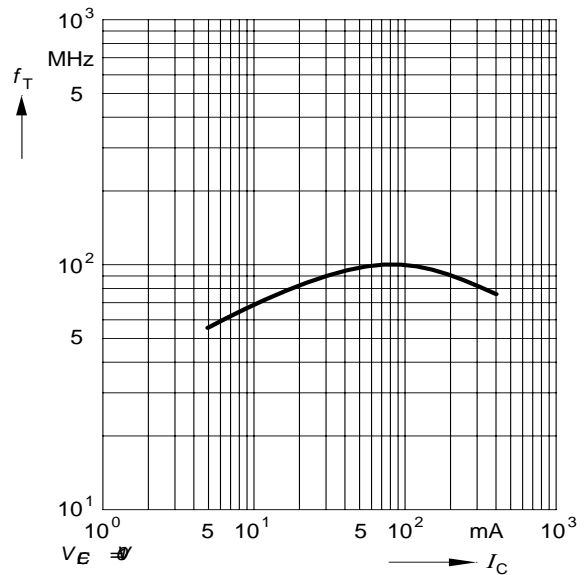

Transition frequency $f_T = f(I_C)$

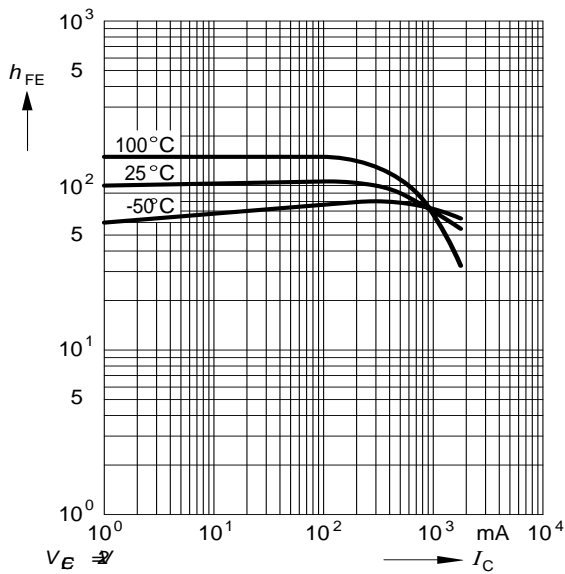

DC current gain $h_{FE} = f(I_C)$

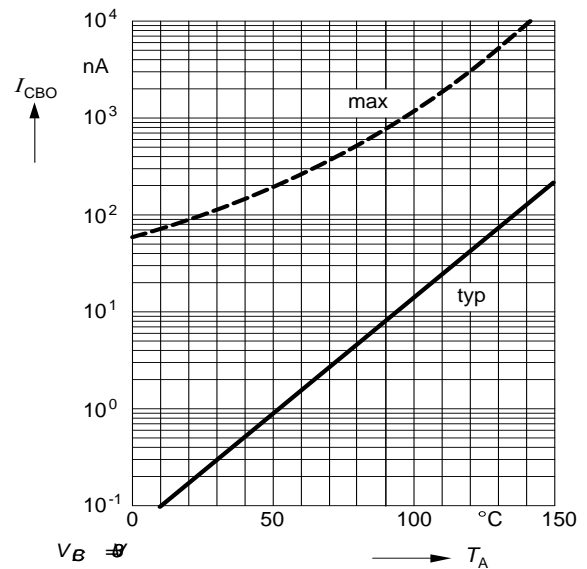

Collector cutoff current $I_{CBO} = f(T_A)$

BCP56-16

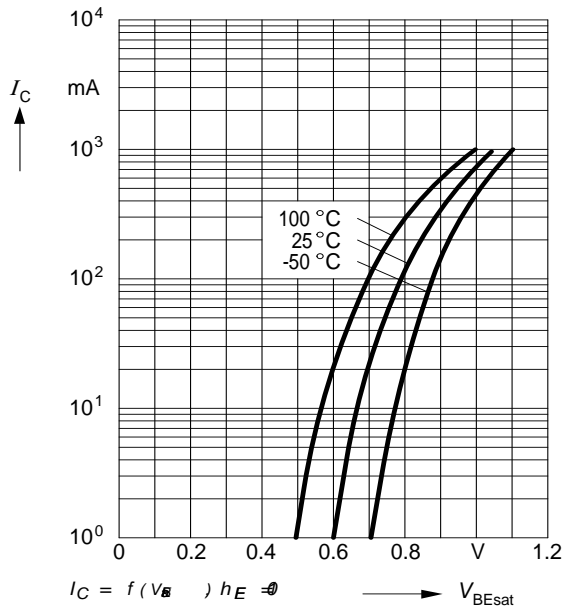

Base-emitter saturation voltage

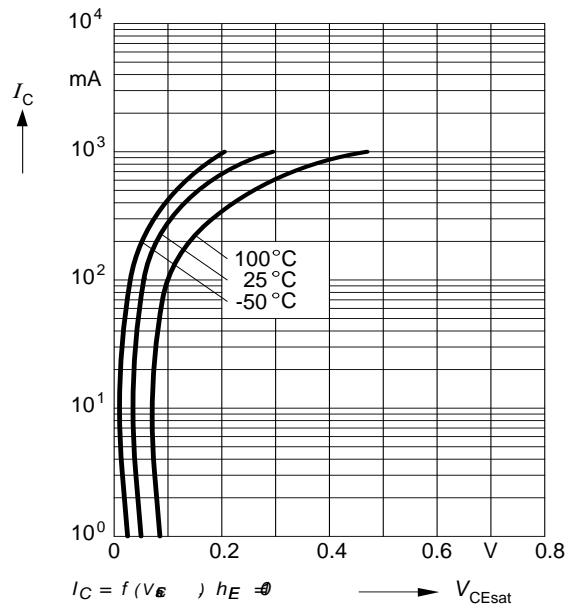

Collector-emitter saturation voltage

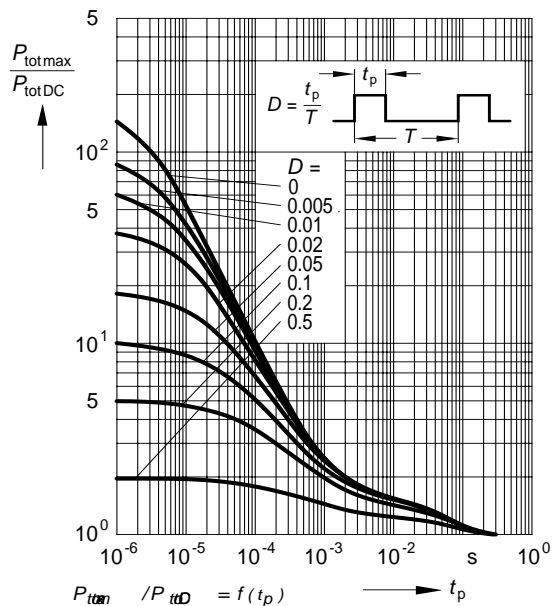

Permissible pulse load