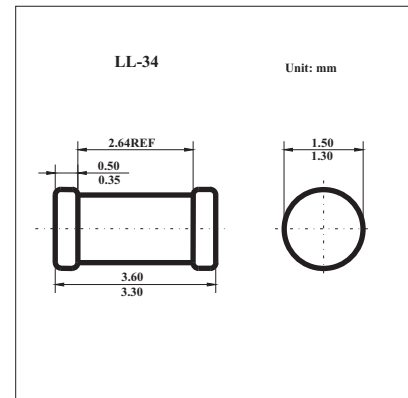

Surface Mount Zener Diode

BZT55C43

■ Features

- 500mW Power Dissipation
- Low reverse current level
- Very high stability
- Low noise
- Ideal for Surface Mounted Application

■ Absolute Maximum Ratings $T_a = 25^\circ\text{C}$

Parameter	Symbol	Rating	Unit
Power Dissipation (Note 1)	P_D	500	mW
Forward Voltage @ $I_F = 200\text{mA}$	V_F	1.5	V
Thermal Resistance, Junction to Ambient Air (Note 1)	$R_{\theta JA}$	300	$^\circ\text{C}/\text{W}$
Operating and Storage Temperature Range	T_j, T_{STG}	-65 to +175	$^\circ\text{C}$

Notes: 1. Valid provided that electrodes are kept at ambient temperature.

■ Electrical Characteristics $T_a = 25^\circ\text{C}$

Type	Zener Voltage Range (Note 2)			Maximum Zener Impedance			Maximum Reverse Current		
	$V_Z @ I_{ZT}$			I_{ZT}	$Z_{ZT} @ I_{ZT}$	$Z_{ZK} @ I_{ZK}$	I_{ZK}	$I_R @ V_R$	
	Nom (V)	Min (V)	Max (V)	mA	Ω	Ω	mA	μA	V
BZT55C43	43	40	46	2.5	90	600	0.5	0.1	33

Notes: 2. Tested with pulses, $T_p \leq 100\text{ms}$.

BZT55C43

■ Typical Characteristics

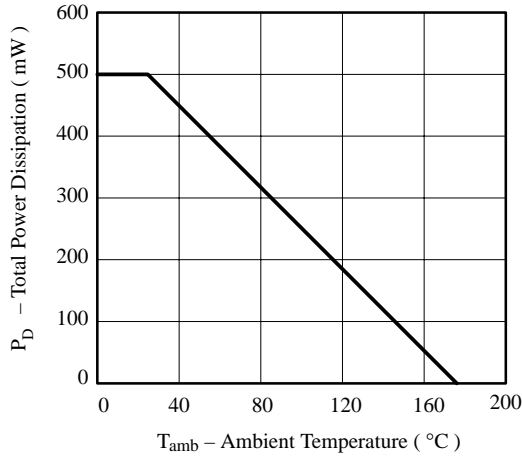

Figure 1. Total Power Dissipation vs. Ambient Temperature

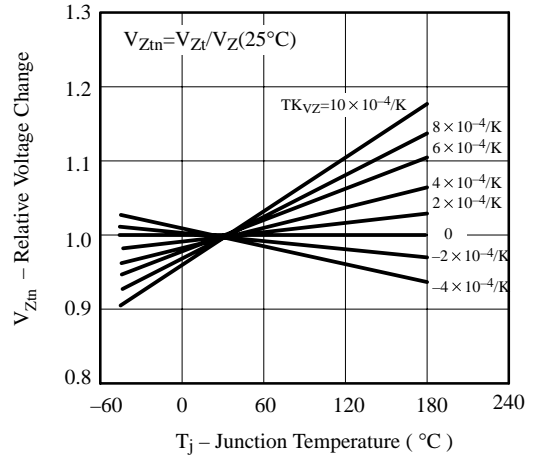

Figure 2. Typical Change of Working Voltage vs. Junction Temperature

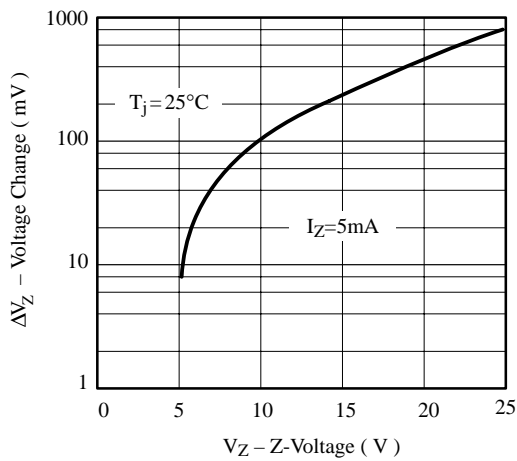

Figure 3. Typical Change of Working Voltage under Operating Conditions at $T_{amb}=25^{\circ}C$

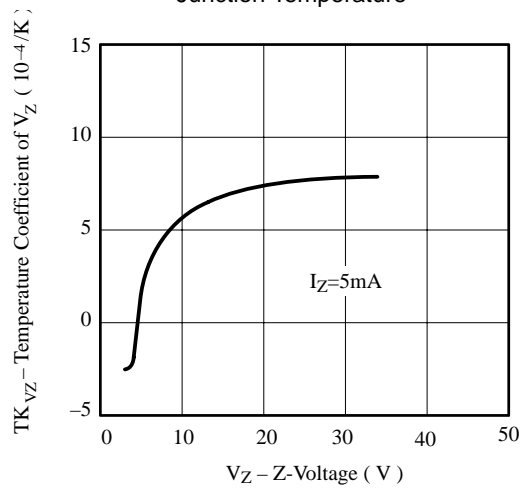

Figure 4. Temperature Coefficient of V_Z vs. Z-Voltage

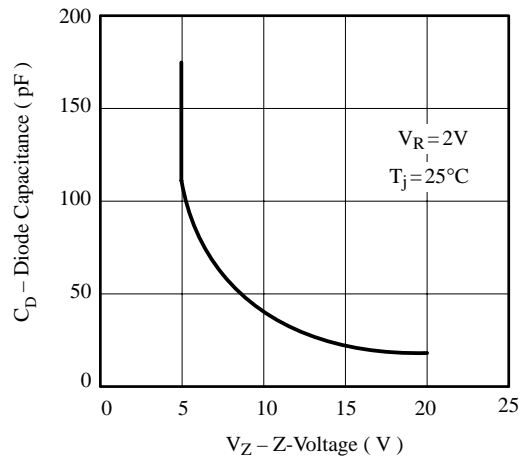

Figure 5. Diode Capacitance vs. Z-Voltage

BZT55C43

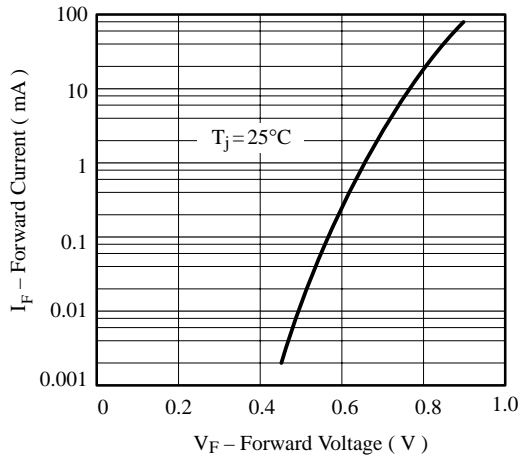

Figure 6. Forward Current vs. Forward Voltage

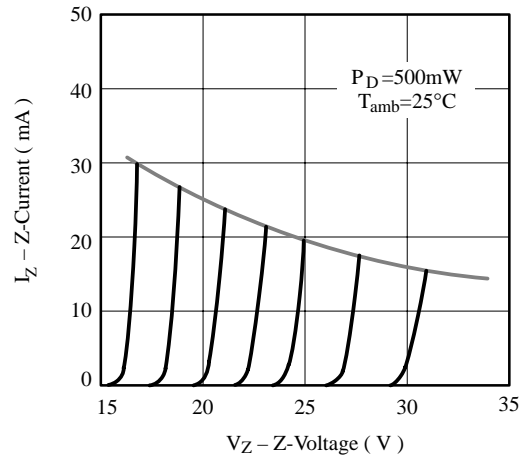

Figure 7. Z-Current vs. Z-Voltage

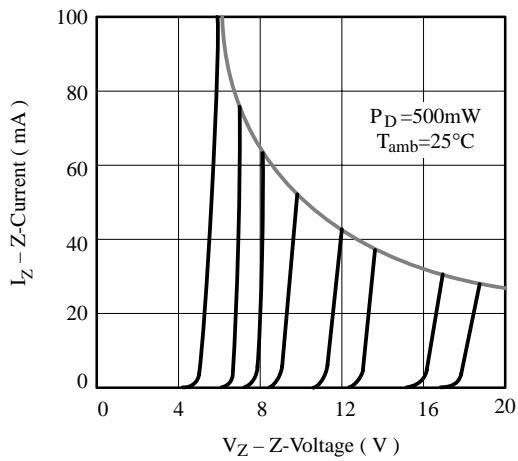

Figure 8. Z-Current vs. Z-Voltage

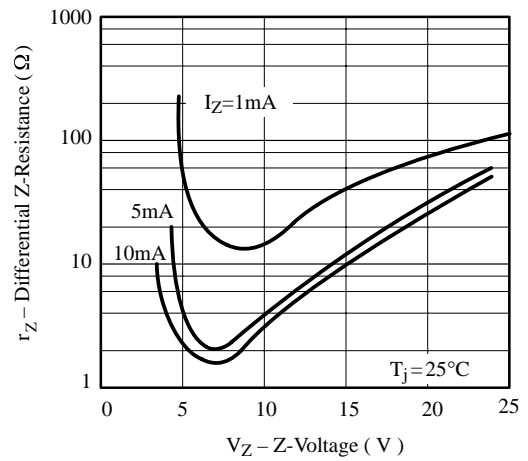

Figure 9. Differential Z-Resistance vs. Z-Voltage

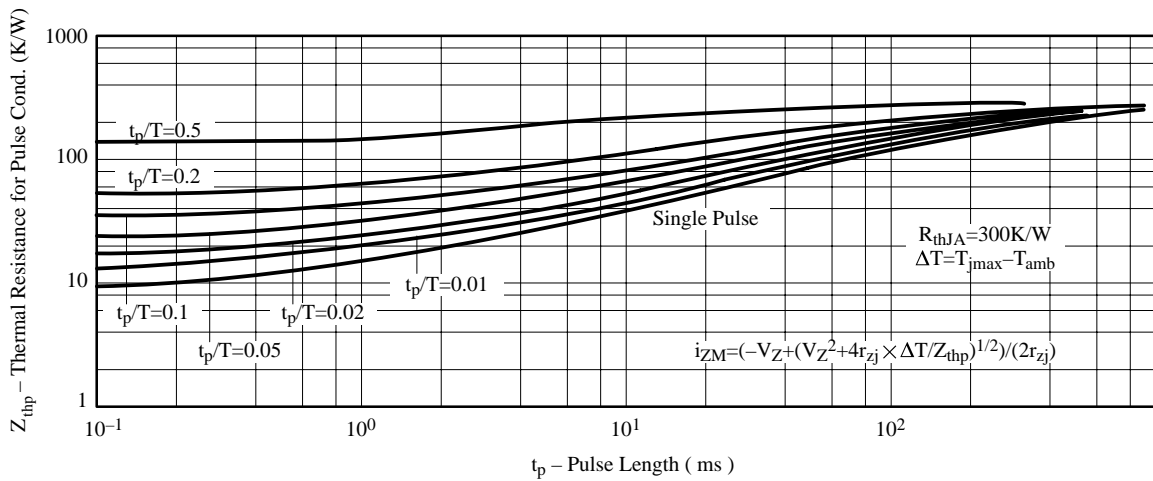

Figure 10. Thermal Response