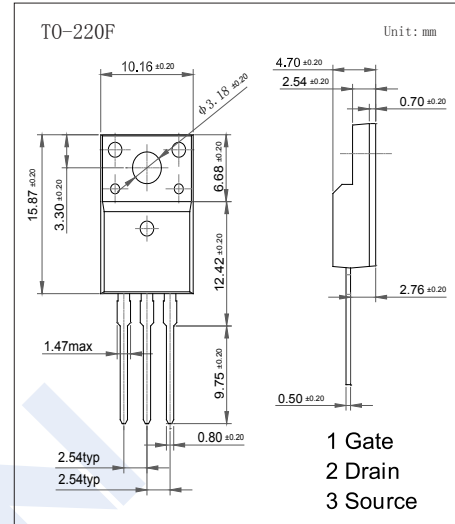

## N-Channel Enhancement MOSFET

## KX6N70F

## ■ Features

- $V_{DS} (V) = 700V$
- $I_D = 6.0A (V_{GS} = 10V)$
- $R_{DS(ON)} < 1.8 \Omega (V_{GS} = 10V)$
- Low gate charge ( typical 16nC)

■ Absolute Maximum Ratings  $T_a = 25^\circ C$ 

Parameter	Symbol	Rating	Unit
Drain-Source Voltage	$V_{DS}$	700	V
Gate-Source Voltage	$V_{GS}$	$\pm 30$	
Continuous Drain Current	$I_D$	$T_c=25^\circ C$	A
		$T_c=100^\circ C$	
Pulsed Drain Current (Note.1)	$I_{DM}$	24	mJ
Avalanche Current (Note.1)	$I_{AR}$	6.0	
Repetitive Avalanche Energy (Note.1)	$E_{AR}$	14.7	
Single Pulsed Avalanche Energy (Note.2)	$E_{AS}$	150	W
Power Dissipation	$P_D$	$T_c=25^\circ C$	
		Derate above $25^\circ C$	$0.38$
Peak Diode Recovery $dv/dt$ (Note.3)	$dv/dt$	4.5	$V/ns$
Thermal Resistance.Junction- to-Ambient	$R_{thJA}$	62.5	$^\circ C/W$
Thermal Resistance.Junction- to-Case	$R_{thJC}$	2.6	
Maximum lead Temperature for soldering purpose, 1/8 from case for 5 seconds	$T_L$	300	$^\circ C$
Junction Temperature	$T_J$	150	
Storage Temperature Range	$T_{stg}$	-55 to 150	

Note.1: Repetitive Rating :Pulse width limited by maximum junction temperature

Note.2:  $L=8mH, I_{AS}=6.0A, V_{DD}=50V, R_G=25\Omega, \text{Starting } T_J=25^\circ C$

Note.3:  $I_{SD} \leq 6.0A, di/dt \leq 200A/us, V_{DD} \leq BV_{DSS}, \text{Starting } T_J=25^\circ C$

## N-Channel Enhancement MOSFET

### KX6N70F

#### ■ Electrical Characteristics Ta = 25°C

Parameter	Symbol	Test Conditions	Min	Typ	Max	Unit
Drain-Source Breakdown Voltage	V <sub>DSS</sub>	I <sub>D</sub> =250 μA, V <sub>GS</sub> =0V	700			V
Zero Gate Voltage Drain Current	I <sub>DSS</sub>	V <sub>DS</sub> =700V, V <sub>GS</sub> =0V			1	μA
		V <sub>DS</sub> =560V, V <sub>GS</sub> =0V, T <sub>c</sub> =125°C			10	
Gate-Body Leakage Current	I <sub>GSS</sub>	V <sub>DS</sub> =0V, V <sub>GS</sub> =±30V			±100	nA
Gate Threshold Voltage	V <sub>GS(th)</sub>	V <sub>DS</sub> =V <sub>GS</sub> , I <sub>D</sub> =250 μA	2.0		4.0	V
Static Drain-Source On-Resistance	R <sub>DS(on)</sub>	V <sub>GS</sub> =10V, I <sub>D</sub> =3.0A		1.8	2.3	Ω
Input Capacitance	C <sub>iss</sub>	V <sub>GS</sub> =0V, V <sub>DS</sub> =25V, f=1MHz		650		pF
Output Capacitance	C <sub>oss</sub>			95		
Reverse Transfer Capacitance	C <sub>rss</sub>			10		
Total Gate Charge	Q <sub>g</sub>	V <sub>GS</sub> =10V, V <sub>DS</sub> =560V, I <sub>D</sub> =6.0A (Note.1)		16		nC
Gate Source Charge	Q <sub>gs</sub>			4.5		
Gate Drain Charge	Q <sub>gd</sub>			5.0		
Turn-On DelayTime	t <sub>d(on)</sub>	I <sub>D</sub> =6.0A, V <sub>DS</sub> =350V, R <sub>GEN</sub> =25Ω (Note.1)		30		ns
Turn-On Rise Time	t <sub>r</sub>			40		
Turn-Off DelayTime	t <sub>d(off)</sub>			80		
Turn-Off Fall Time	t <sub>f</sub>			40		
Body Diode Reverse Recovery Time	t <sub>rr</sub>	I <sub>S</sub> = 6.0A, di/dt= 100A/μs V <sub>GS</sub> =0V (Note.1)		280		uC
Body Diode Reverse Recovery Charge	Q <sub>rr</sub>			2.0		
Maximum Body-Diode Continuous Current	I <sub>S</sub>	Maximum Continuous Drain-Source Diode Forward Current			6.0	A
Maximum Pulsed Drain-Source Current	I <sub>SM</sub>	Maximum Pulsed Drain-Source Diode Forward Current			24	
Diode Forward Voltage	V <sub>SD</sub>	I <sub>S</sub> =6.0A, V <sub>GS</sub> =0			1.4	V

Note.1: Pulse Test:Pulse width ≤300us,Duty cycle ≤2%

# N-Channel Enhancement MOSFET

## KX6N70F

### Typical Characteristics

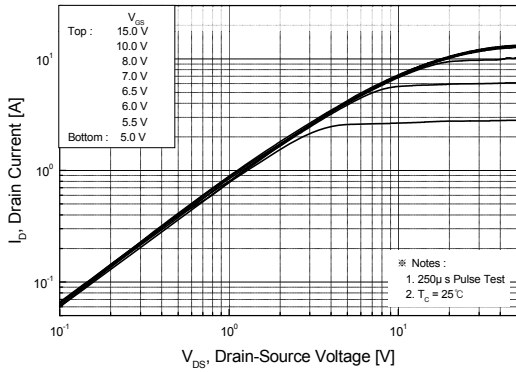

Figure 1. On-Region Characteristics

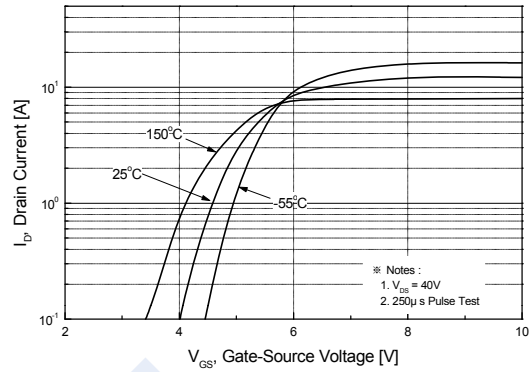

Figure 2. Transfer Characteristics

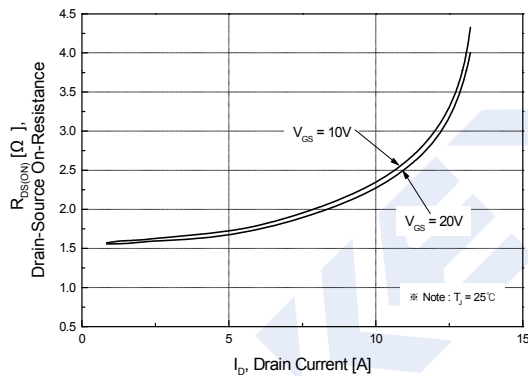

Figure 3. On-Resistance Variation vs Drain Current and Gate Voltage

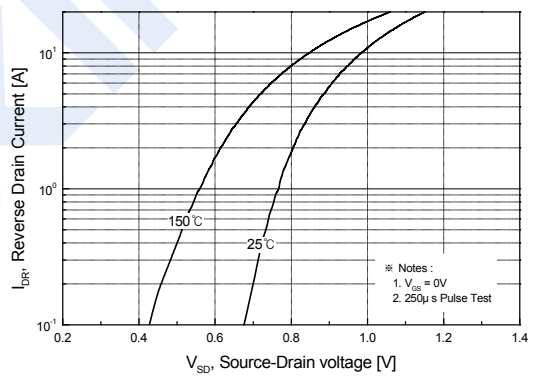

Figure 4. Body Diode Forward Voltage Variation with Source Current and Temperature

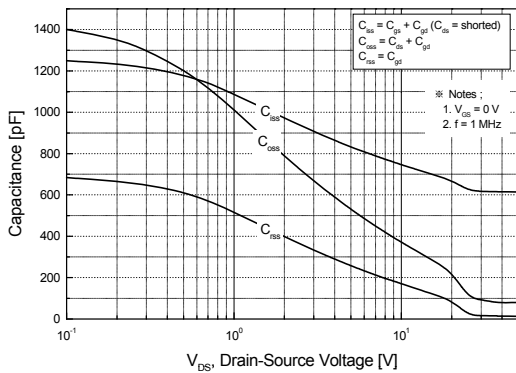

Figure 5. Capacitance Characteristics

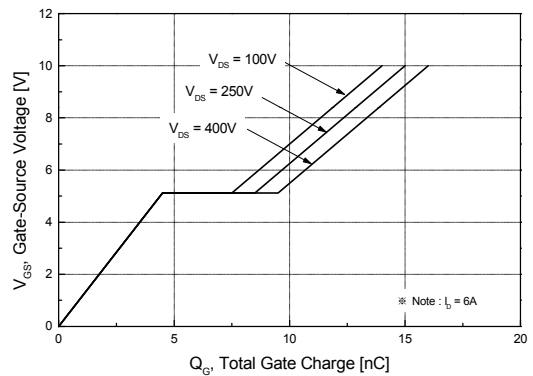

Figure 6. Gate Charge Characteristics

## N-Channel Enhancement MOSFET KX6N70F

■ Typical Characteristics

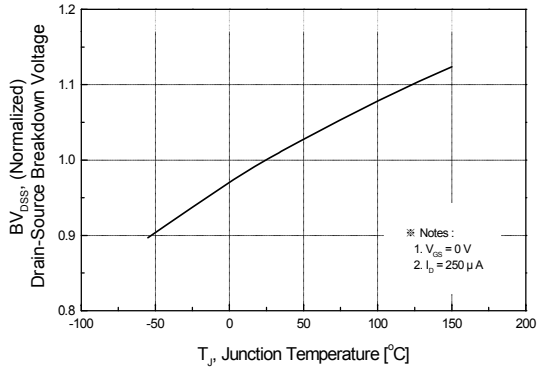

Figure 7. Breakdown Voltage Variation vs Temperature

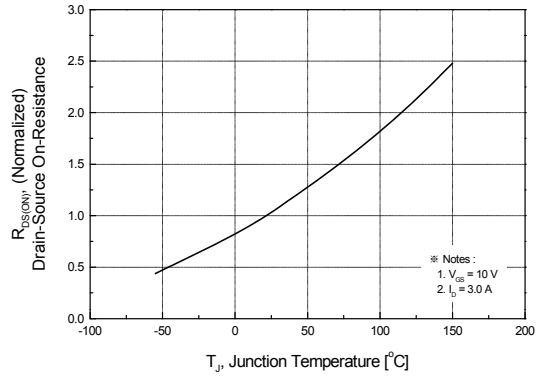

Figure 8. On-Resistance Variation vs Temperature

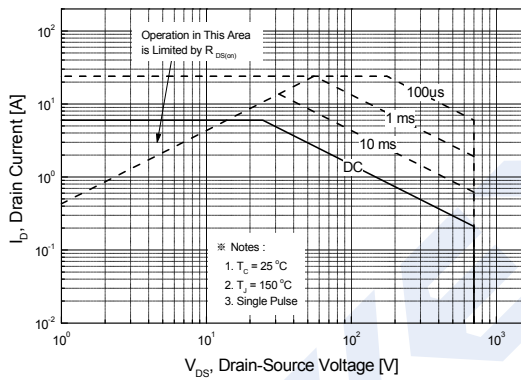

Figure 9. Maximum Safe Operating Area for KX6N70F

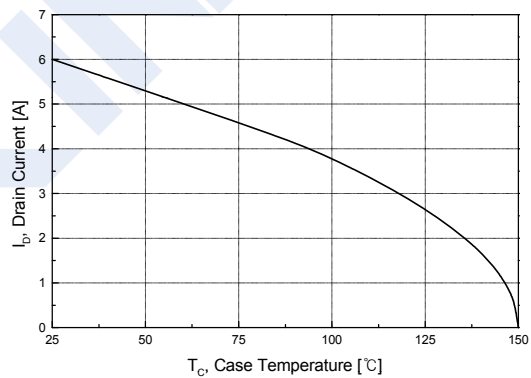

Figure 10. Maximum Drain Current vs Case Temperature

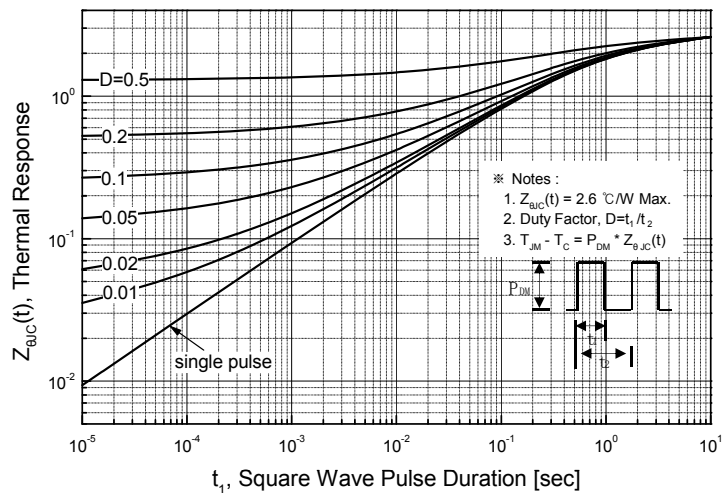

Figure 11. Transient Thermal Response Curve for KX6N70F