

PNP Transistors

MMBTA55 (KMBTA55)

■ Features

- Collector Current Capability $I_C = -0.5A$
- Collector Emitter Voltage $V_{CE0} = -60V$

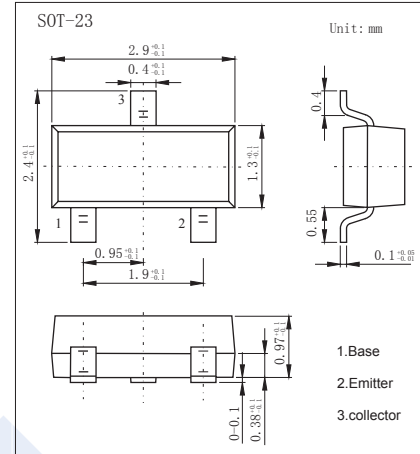
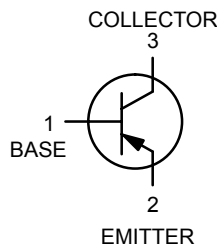

■ Absolute Maximum Ratings $T_a = 25^\circ C$

Parameter	Symbol	Rating	Unit
Collector - Base Voltage	V_{CB0}	-60	V
Collector - Emitter Voltage	V_{CE0}	-60	
Emitter - Base Voltage	V_{EB0}	-4	
Collector Current - Continuous	I_C	-0.5	A
Collector Power Dissipation	P_C	225	mW
Derate Above $25^\circ C$		1.8	mW/ $^\circ C$
Thermal Resistance Junction-to-Ambient	$R_{\theta JA}$	556	$^\circ C/W$
Junction Temperature	T_J	150	$^\circ C$
Storage Temperature range	T_{stg}	-55 to 150	

■ Electrical Characteristics $T_a = 25^\circ C$

Parameter	Symbol	Test Conditions	Min	Typ	Max	Unit
Collector- base breakdown voltage	V_{CB0}	$I_C = -100 \mu A, I_E = 0$	-60			V
Collector- emitter breakdown voltage	V_{CE0}	$I_C = -1 mA, I_B = 0$	-60			
Emitter - base breakdown voltage	V_{EB0}	$I_E = -100 \mu A, I_C = 0$	-4			
Collector-base cut-off current	I_{CB0}	$V_{CB} = -60 V, I_E = 0$			-0.1	uA
Collector cut-off current	I_{CES}	$V_{CE} = -60 V, I_E = 0$			-0.1	
Emitter cut-off current	I_{EBO}	$V_{EB} = -4V, I_C = 0$			-0.1	
Collector-emitter saturation voltage	$V_{CE(sat)}$	$I_C = -100 mA, I_B = -10mA$			-0.25	V
Base - emitter saturation voltage	$V_{BE(sat)}$	$I_C = -100 mA, I_B = -10mA$			-1.2	
Base - emitter on voltage	$V_{BE(on)}$	$V_{CE} = -1V, I_C = -100mA$			-1.2	
DC current gain	h_{FE}	$V_{CE} = -1V, I_C = -10mA$	100			
		$V_{CE} = -1V, I_C = -100mA$	100			
Transition frequency	f_T	$V_{CE} = -1V, I_C = -100mA, f = 100MHz$	50			MHz

Note. Pulse Test: Pulse Width $\leq 300 \mu s$, Duty Cycle $\leq 2.0\%$.

■ Marking

Marking	2H
---------	----

PNP Transistors MMBTA55 (KMBTA55)

■ Typical Characteristics

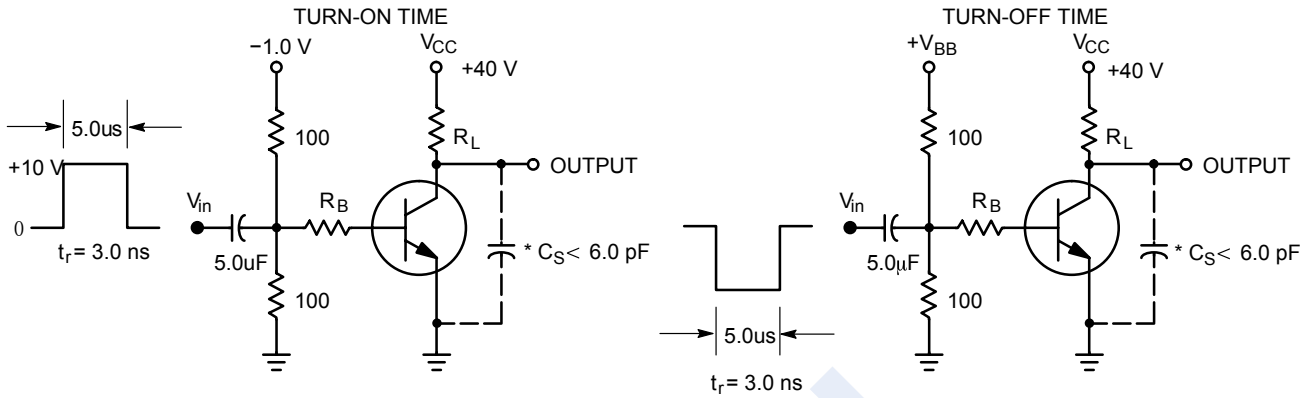

Figure 1. Switching Time Test Circuits

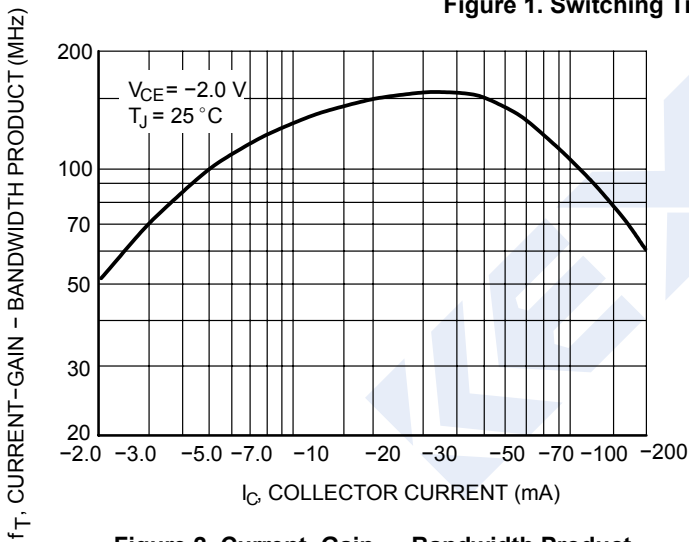

Figure 2. Current-Gain — Bandwidth Product

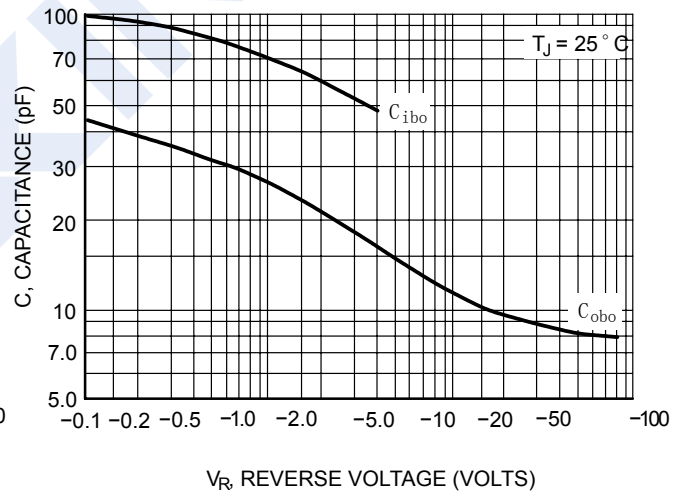

Figure 3. Capacitance

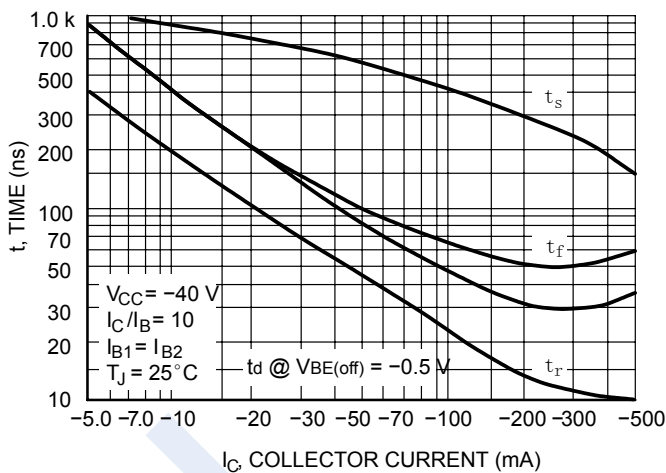

Figure 4. Switching Time

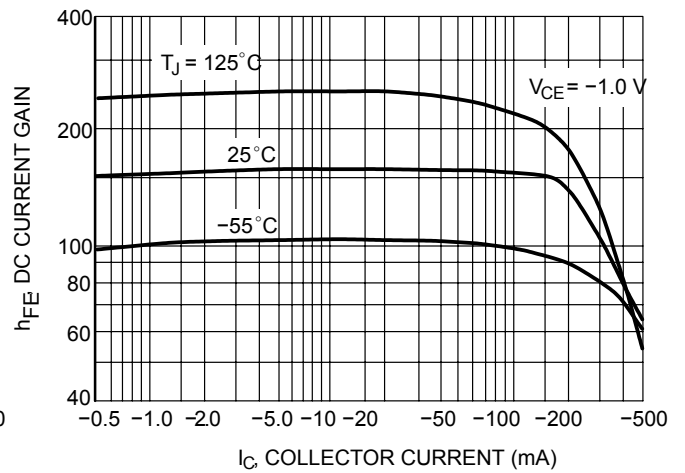

Figure 5. DC Current Gain

PNP Transistors

MMBTA55 (KMBTA55)

■ Typical Characteristics

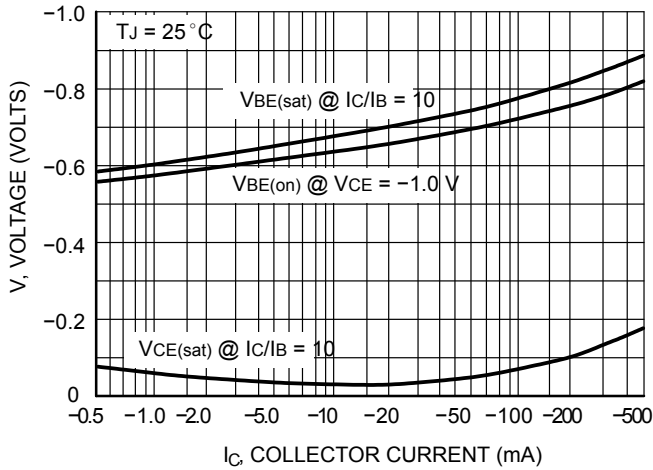

Figure 6. "ON" Voltages

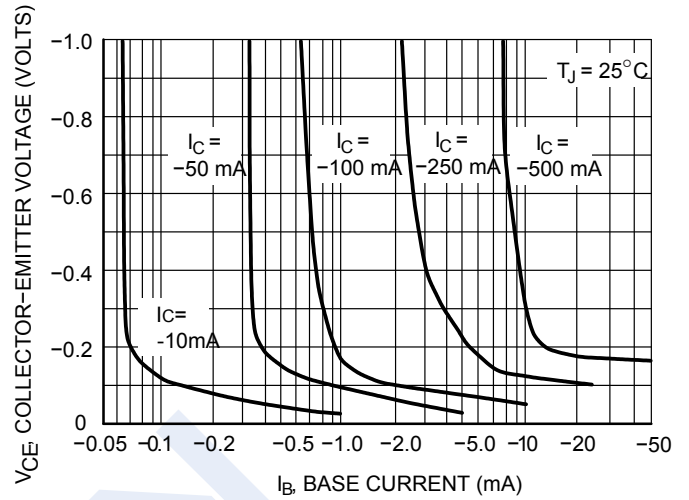

Figure 7. Collector Saturation Region

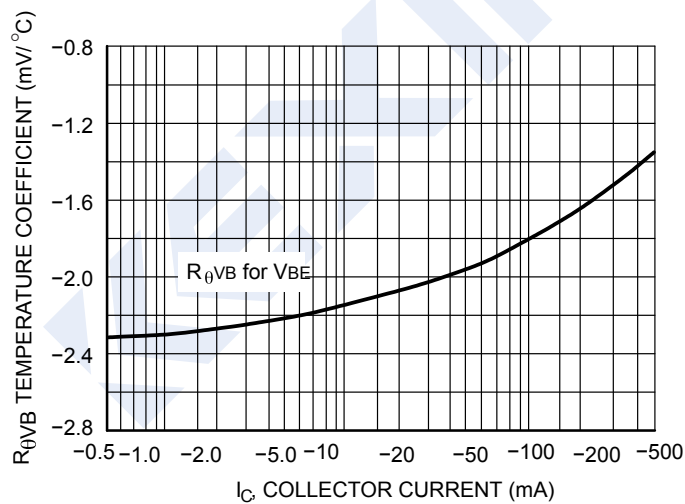

Figure 8. Base-Emitter Temperature Coefficient